

99241

Dimensions

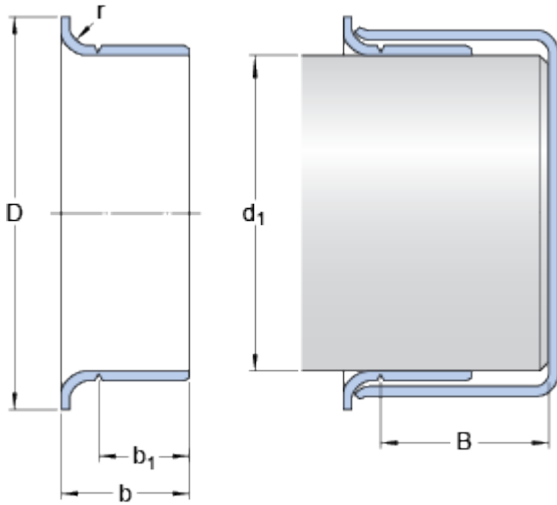

Nominal dimensions

d_1		60	mm
D		70.739	mm
Tolerance outside diameter D	\pm	1.6	mm
b		11.43	mm
Tolerance width b	\pm	0.8	mm
b_1		9.398	mm
Tolerance width b_1	\pm	0.8	mm
B	max.	37.363	mm
r	max.	3.18	mm

Shaft diameter range

d_1	min.	59.919	mm
d_1	max.	60.071	mm